

# Defibtech DDU-2300 Semi-Automatic External Defibrillator



## Operating Guide

## Notices

Defibtech shall not be liable for errors contained herein or for incidental or consequential damages in connection with the furnishing, performance, or use of this material.

Information in this document is subject to change without notice. Names and data used in the examples are fictitious unless otherwise noted.

For more detailed information regarding the Defibtech DDU-2300 AED, please refer to the User Manual on the Defibtech User CD.

## Limited Warranty

The “Limited Warranty” shipped with Defibtech AED products serves as the sole and exclusive warranty provided by Defibtech, LLC with respect to the products contained herein.

## Copyright

Copyright © 2011 Defibtech, LLC

All rights reserved. Copyright questions should be directed to Defibtech. For contact information, refer to the “[Contacts](#)” section of this guide



**Federal Law (USA) restricts this device to sale by or on the order of a physician.**

## Contents

<b>Quick Use Instructions.....</b>	<b>2</b>
<b>When To Use .....</b>	<b>3</b>
<b>Diagram Of Components.....</b>	<b>4</b>
<b>Setting Up The AED.....</b>	<b>6</b>
<b>Using The AED .....</b>	<b>8</b>
<b>Checking AED Status .....</b>	<b>12</b>
<b>Routine Maintenance.....</b>	<b>13</b>
<b>The Electrode Pads.....</b>	<b>14</b>
<b>The Battery Pack.....</b>	<b>15</b>
<b>Dangers, Warnings, And Cautions.....</b>	<b>16</b>
<b>Technical Specifications.....</b>	<b>18</b>
<b>Warranty Information.....</b>	<b>20</b>
<b>Contacts.....</b>	<b>21</b>

Click any of the section headings above to be automatically re-directed to that page.

See page references noted throughout this guide for other interactive links.

*This DDU-2300 Operating Guide is to be used for quick reference. For comprehensive information go to the User Manual on the Defibtech User CD.*

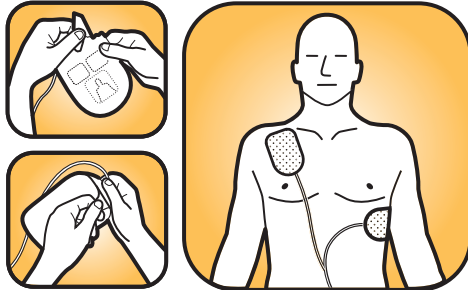
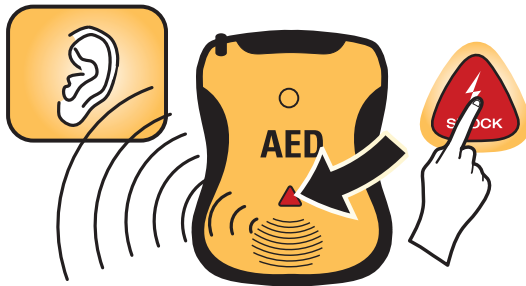
**PRESS "ON"  
BUTTON****1****APPLY PADS  
FOLLOW AED  
INSTRUCTIONS****2****IF INSTRUCTED,  
PRESS "SHOCK"  
BUTTON****3****WHEN TO USE THE AED**

Use the AED when the patient is:

- Unconscious
- Unresponsive
- Not breathing

For patients under 8 years old or less than 55 pounds (25kgs), use child/infant electrode pads. Do not delay therapy to determine exact age or weight.

**WHEN NOT TO USE THE AED**

The AED should not be used if the patient is:

- Conscious and/or responsive
- Breathing
- Has a detectable pulse

**WHO SHOULD USE THE AED**

The user should have:

- Defibrillation training as required by local, state, provincial, or national regulations.
- Any additional training as required by the authorizing physician.
- Thorough knowledge and understanding of the material presented in this Operating Guide and in the User Manual (on Defibtech User CD).



# DIAGRAM OF COMPONENTS

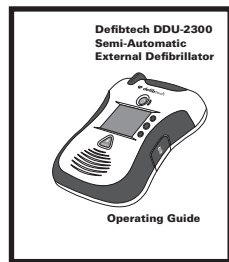
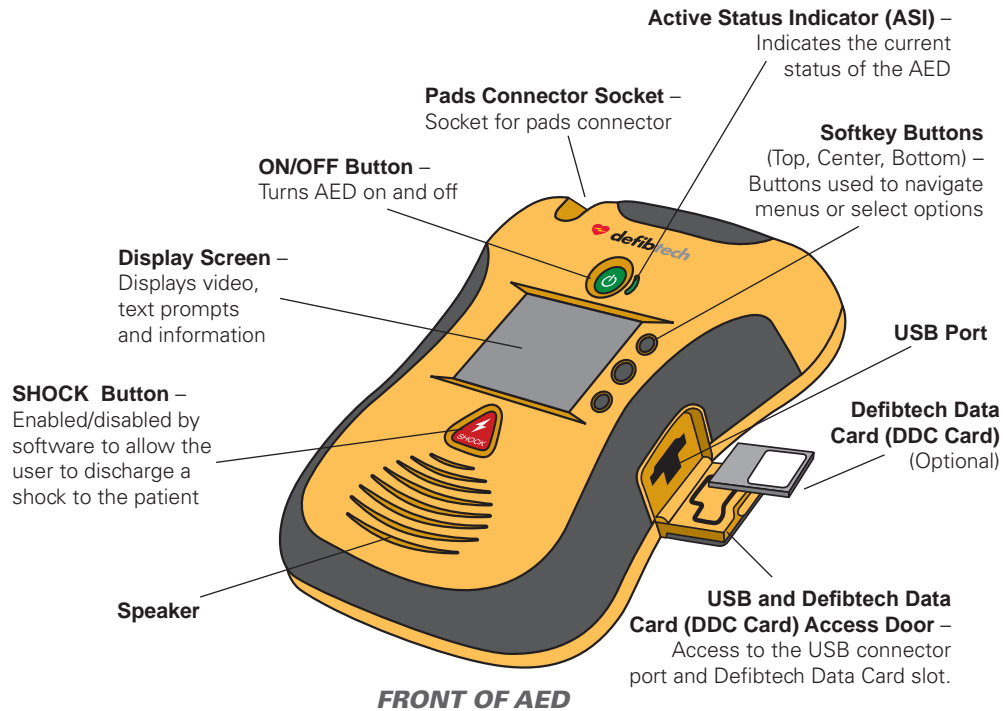

## OPERATING GUIDE BOOKLET

Quick Reference



## DEFIBTECH USER CD

Comprehensive User Manual can be found on the CD

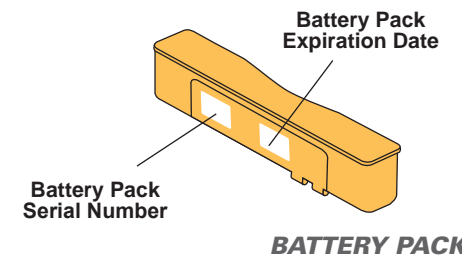
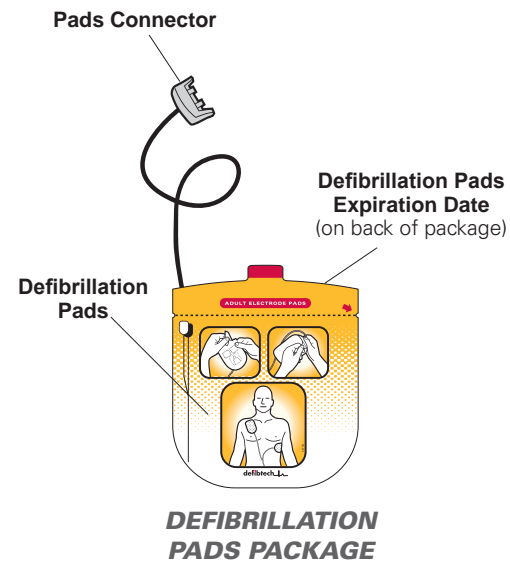
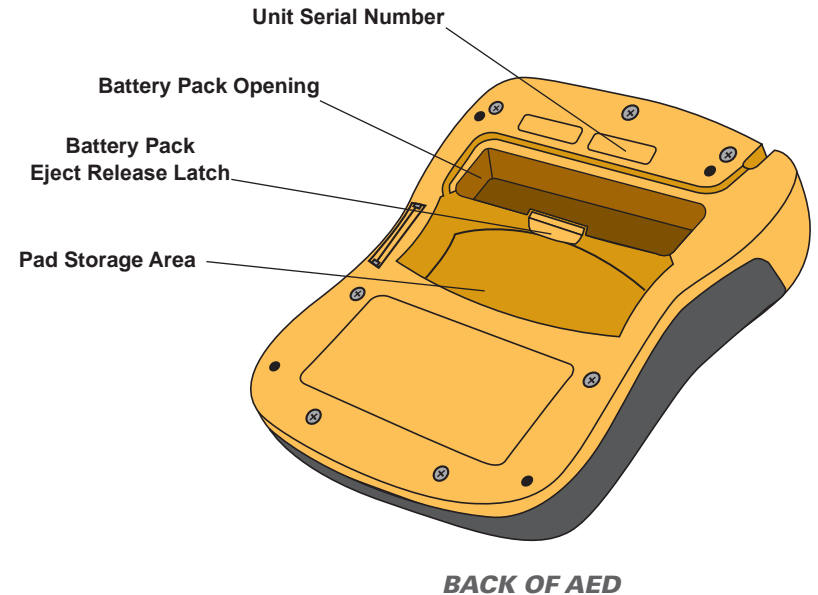

The DDU-2300 AED is designed to be stored in a “ready” state so that few steps are required to begin using the AED.

## CONNECT THE PADS TO THE AED

# 1



Ensure that the pads package has not expired. Expired pads must not be used.

For more information refer to [page 14](#) of this guide.

## INSTALL THE BATTERY PACK

# 2

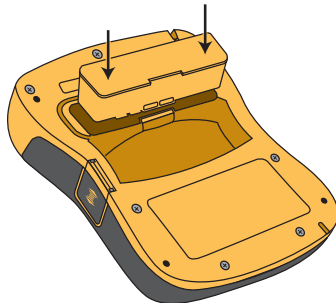

Ensure that the battery pack has not expired. Expired battery packs must not be used.

When the battery pack is installed, the AED will turn on and run a battery pack test. Wait for the test to complete and for the unit to turn off.

For more information refer to [page 15](#) of this guide.

## CHECK THE STATUS

# 3



AED Status Screen

With the AED off, press and release the CENTER softkey button. Ensure that the AED Status Screen appears and that the “AED Status” is “OK”.

## AND

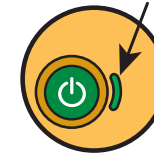

When the AED is off, the Active Status Indicator (ASI) should flash green. If the ASI flashes red, is solid red, or if there is no flashing light, the unit requires service.

For more information refer to [page 12](#) of this guide.

## READ THE USER MANUAL (CD)

# 4



Comprehensive information about the DDU-2300 Defibtech AED is found in the User Manual (on Defibtech User CD).



Turn the unit ON and then follow the voice and display instructions.

**TURN  
AED ON**

**1**



Press "ON" button

**PREPARE  
THE PATIENT**

**2**

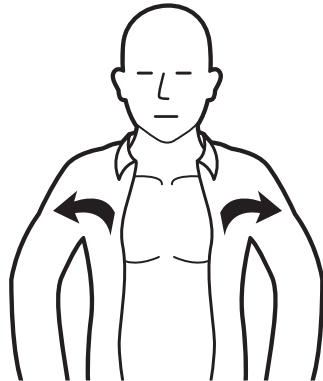

Remove clothing from patient's chest.  
If necessary, shave excessive chest hair.

**PREPARE  
ELECTRODE  
PADS**

**3**

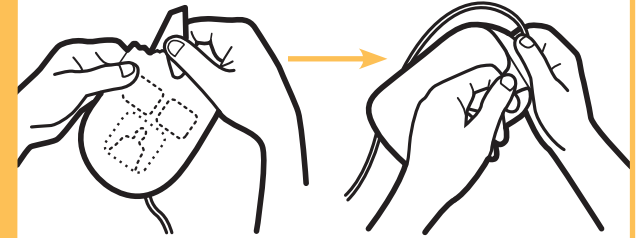

Tear open  
pads package

Peel pads  
from blue liner

**PLACE PADS**

**4**

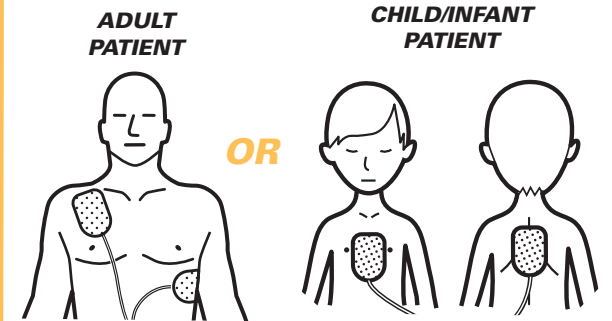

**ADULT  
PATIENT**

**CHILD/INFANT  
PATIENT**

**OR**

Apply pads to patient's  
bare chest as shown



**Note:**

When this **Information Softkey Icon** is present on the screen, the user may press the corresponding softkey button for additional information with video instruction. To exit, press the softkey button again.

**STAND CLEAR**

**5**

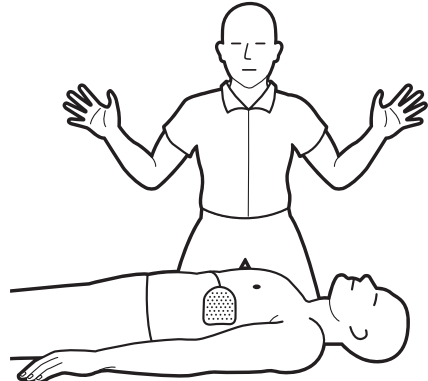

When instructed, do not touch the patient

**IF INSTRUCTED,  
PRESS SHOCK  
BUTTON**

**6**



If instructed, press "SHOCK" button

**PERFORM CPR**

**7**

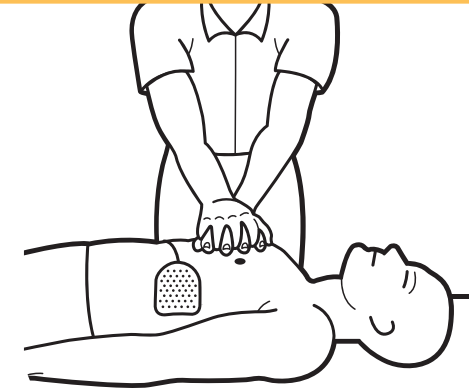

Follow instructions to perform CPR

**CONTINUE  
TO FOLLOW  
INSTRUCTIONS**

**8**



Continue to follow the voice  
and display instructions



**Note:**

When this **Information Softkey Icon** is present on the screen, the user may press the corresponding softkey button for additional information with video instruction. To exit, press the softkey button again.



## ACTIVE STATUS INDICATOR (ASI)

Visually check the Active Status Indicator (ASI) on a daily basis. The ASI should flash green. If the ASI flashes red, is solid red, or if there is no flashing light, the unit requires service. Anytime the ASI flashes red, the unit will also “beep” periodically to call attention to itself.

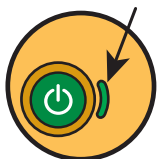

**Active Status Indicator**

- **Flashing Green:** DDU-2300 AED is OFF and ready for use.
- **Solid Green:** DDU-2300 AED is ON and ready for use.
- **Flashing or Solid Red:** DDU-2300 AED needs immediate service. Refer to the “*Troubleshooting*” section of the User Manual (on Defibtech User CD) or call Defibtech for service.
- **No Flashing Light:** DDU-2300 AED needs immediate service. Refer to the “*Troubleshooting*” section of the User Manual (on Defibtech User CD) or call Defibtech for service.

## AED STATUS SCREEN

The AED Status Screen is used to provide a quick overview of the DDU-2300 AED’s status and to display select information without turning the unit on in Rescue Mode.

With the AED off, press and release the **CENTER** softkey button to display the AED Status Screen. The AED Status Screen will be displayed for a short period of time.

If the unit does not turn on, check to make sure a good battery pack is installed. (Refer to the “*Troubleshooting*” section of the User Manual (on Defibtech User CD).



**AED Status Screen**

Although the DDU-2300 AED is designed to be very low maintenance, simple maintenance tasks must be performed by the owner/operator on a regular basis to ensure the unit’s dependability.

Daily	Monthly	After Each Use	Action
●		●	Check that the Active Status Indicator is flashing green
	●	●	Check the condition of the unit and accessories
		●	Run manually initiated self-test
		●	Replace pads
	●		Check pad and battery pack expiration dates
		●	Check the DDC card, if one was installed

If the unit needs attention, refer to the “*Troubleshooting*” section of the User Manual (on Defibtech User CD) or call Defibtech for service. For contact information, refer to the “*Contacts*” section of this guide.

## MAINTENANCE MODE

Maintenance Mode permits the user to perform maintenance-related actions such as viewing unit information, initiating unit self-tests, changing unit parameters, downloading rescue data, and upgrading software.



To enter Maintenance Mode press the bottom softkey button to the right of the **tool icon** on the AED Status Screen.

For instructions on how to access the AED Status Screen, see previous page. To exit Maintenance Mode, simply turn the unit off by pressing the ON/OFF button. For comprehensive information about Maintenance Mode refer to Chapter 6 of the User Manual (on Defibtech User CD).

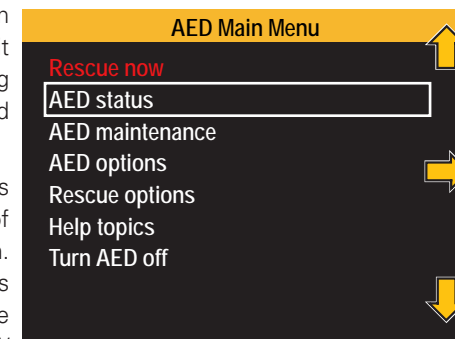

**The Display Screen During Maintenance Mode**



### HOW TO CONNECT THE PADS

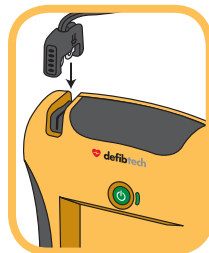

Insert the connector end of the defibrillation pad cable into the pads connector socket on the top-left corner of the DDU-2300 AED as shown. Insert pads connector firmly until it is fully seated in the unit. The connector will only fit in one way – if the connector does not fit, rotate the connector before trying again.

The connected pads package can then be stored in the pad storage slot in the back of the DDU-2300 AED. After connecting the pads connector to the unit, push the pads package, rounded end first, with the pictures on the package facing out, into the pad holder compartment on the back of the AED. When the pads package is fully inserted, press the pad cable into the groove in the back of the unit to hold the cable in place and tuck any excess cable behind the pads package.

### WHICH PADS TO USE

#### ADULT PADS

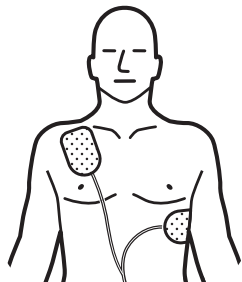

For adults and children 8 years or older or over 55 pounds (25kgs), use adult pads

#### CHILD/INFANT PADS

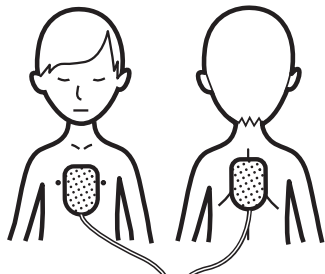

For infants and children under 8 years or less than 55 pounds (25kgs), use child/infant pads (Note: child/infant pads can be identified by their blue connector and pads package)

### WHEN TO REPLACE THE PADS

The Defibtech defibrillation pads are intended for one time use only. The pads must be replaced after each use or if the package has been damaged.

It is important to check the expiration date of the pads. The expiration date is printed on the outside of the sealed package. *Do not use pads past their expiration date.* Discard expired pads. *Use only Defibtech electrode pads.*

You may also check the status of the pads when the unit is off by pressing the center softkey button to display the AED Status Screen and enter Maintenance Mode.

### HOW TO INSERT AND REMOVE THE BATTERY PACK

Before inserting the battery pack into the DDU-2300 AED, ensure that the battery pack opening in the back of the AED is clean and clear of any foreign objects. Insert the battery pack into the opening in the back of the AED.

Push the pack all the way in until the latch clicks. The battery pack will only fit in one way. If the battery pack does not fit, rotate the battery pack before trying again. Once fully inserted, the battery pack surface should be flush with the back of the AED. Within moments of insertion, the DDU-2300 AED will turn on and run a battery pack insertion test. When the test is completed, the unit will report the status of the battery pack and shut down. (The battery pack must be removed from the unit for more than 10 seconds for the battery pack self-test to be performed automatically.)

To remove the battery pack, push the battery pack eject release latch. After the battery pack is partially ejected, pull the battery pack out.

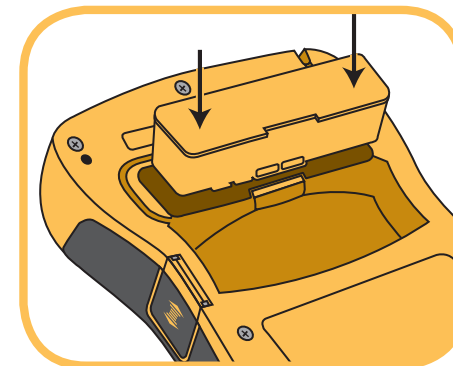

### WHEN TO REPLACE THE BATTERY PACK

It is important to check the expiration date of the battery pack. The expiration date is printed on the label on the battery pack. *The battery pack should be used before the expiration date.* When the battery pack is low, the unit will indicate "battery low" or "replace battery now" and the Active Status Indicator will flash red. The battery pack should be replaced immediately. *Use only Defibtech battery packs.*

You may also check the status of the battery pack when the unit is off by pressing the center softkey button to display the AED Status Screen and enter Maintenance Mode.

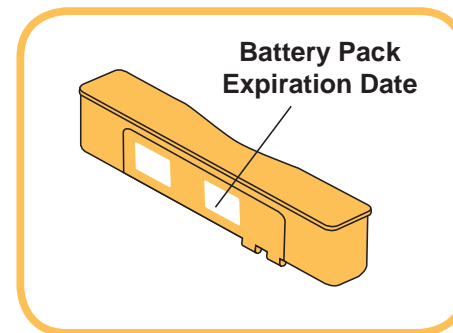

**DANGERS:**

**Immediate hazards that will result in serious personal injury or death.**

- Hazardous electrical output. This equipment is for use only by qualified personnel.
- The DDU-2300 AED is not suitable for use in the presence of a flammable anesthetic mixture.
- Not suitable for use in oxygen enriched atmosphere.
- The DDU-2300 AED has not been evaluated or approved for use in hazardous locations as defined in the National Electric Code standard. In compliance with IEC classification, the DDU-2300 AED is not to be used in the presence of flammable substance/air mixtures.

**WARNINGS:**

**Conditions, hazards, or unsafe practices that may result in serious personal injury or death.**

- Improper use can cause injury. Use the DDU-2300 AED only as instructed in the User Manual. The DDU-2300 AED delivers electrical energy that can potentially cause death or injury if it is used or discharged improperly.
- Improper maintenance can cause the DDU-2300 AED not to function. Maintain the DDU-2300 AED only as described in the User Manual. The AED contains no user serviceable parts – do not take the unit apart.
- Electrical Shock Hazard. Dangerous high voltages and currents are present. Do not open unit, remove cover (or back), or attempt repair. There are no user serviceable components in the DDU-2300 AED. Refer servicing to qualified service personnel.
- Lithium battery packs are not rechargeable. Any attempt to recharge a lithium battery pack may result in fire or explosion.

**WARNINGS (continued)**

- Do not immerse battery pack in water or other liquids. Immersion in fluids may result in fire or explosion.
- Do not let fluids get into the DDU-2300 AED. Avoid spilling fluids on the AED or its accessories. Spilling fluids into the DDU-2300 AED may damage it or cause a fire or shock hazard.
- Do not sterilize the DDU-2300 AED or its accessories.
- Use only Defibtech disposable self-adhesive defibrillation pads, battery packs, and other accessories supplied by Defibtech or its authorized distributors. Substitution of non-Defibtech approved accessories may cause the device to perform improperly.
- Do not open sealed pads package until the pads are to be used.
- Do not touch the patient during defibrillation. Defibrillation current can cause operator or bystander injury.
- Do not allow pads to touch metal objects or equipment in contact with the patient. Do not touch equipment connected to the patient during defibrillation. Disconnect other electrical equipment from the patient before defibrillation.
- Do not shock with defibrillation pads touching each other. Do not shock with gel surface exposed.
- Do not allow defibrillation pads to touch each other, or to touch other ECG electrodes, lead wires, dressings, transdermal patches, etc. Such contact can cause electrical arcing and patient skin burns during defibrillation and may divert defibrillating energy away from the heart.
- The defibrillation pads are intended for one time use only and must be discarded after use. Reuse can lead to potential cross infection, improper performance of the device, inadequate delivery of therapy and/or injury to the patient or operator.

**WARNINGS (continued)**

- Avoid contact between parts of the patient's body and conductive fluids such as water, gel, blood or saline, and metal objects, which may provide unwanted pathways for defibrillating current.
- Disconnect all non-defibrillator proof equipment from the patient before defibrillation to prevent electrical shock hazard and potential damage to that equipment.
- Aggressive or prolonged CPR to a patient with defibrillation pads attached can cause damage to the pads. Replace the defibrillation pads if they become damaged during use.
- Possible Radio frequency (RF) interference from RF devices such as cellular phones and two-way radios can cause improper AED operation. Normally using a cell phone near the AED should not cause a problem; however, a distance of 2 meters (6 feet) between RF devices and the DDU-2300 AED is recommended.
- CPR during analysis can cause incorrect or delayed diagnosis by the patient analysis system.
- Handling or transporting the patient during ECG analysis can cause incorrect or delayed diagnosis, especially if very low amplitude or low frequency rhythms are present.
- In patients with cardiac pacemakers, the DDU-2300 AED may have reduced sensitivity and not detect all shockable rhythms. If you know the patient has an implanted pacemaker, do not place electrodes directly over an implanted device.
- During defibrillation, air pockets between the skin and defibrillation pads can cause patient skin burns. To help prevent air pockets, make sure self-adhesive defibrillation pads completely adhere to the skin. Do not use dried out or expired defibrillation pads.
- User-initiated and automatic self-tests are designed to assess the DDU-2300 AED's readiness for use. However, no degree of testing can assure performance or detect abuse, damage, or a defect that occurred after the most recent test is completed.

**WARNINGS (continued)**

- Use of damaged equipment or accessories may cause the device to perform improperly and/or result in injury to the patient or operator.

**CAUTIONS:**

**Conditions, hazards, or unsafe practices that may result in minor personal injury, damage to the DDU-2300 AED, or loss of data.**

- Follow all battery pack labeling instructions. Do not install battery packs after the expiration date.
- Follow all defibrillation pad label instructions. Use defibrillation pads prior to their expiration date. Do not re-use defibrillation pads. Discard defibrillation pads after use (in the event of suspected pad malfunction, return pads to Defibtech for testing).
- Recycle or dispose of lithium battery packs in accordance with federal, state, and/or local laws. To avoid fire and explosion hazard, do not burn or incinerate the battery pack. Do not crush.
- Use and store the DDU-2300 AED only within the range of environmental conditions specified in the technical specifications.
- If possible, disconnect the DDU-2300 AED from the patient prior to use of other defibrillators.
- Do not connect the DDU-2300 to a PC or other device (using the USB port) while the unit's electrodes are still connected to the patient.
- Using non Defibtech Data Cards (DDC cards) may damage the unit and will void the warranty.
- Although the DDU-2300 AED is designed for a wide variety of field use conditions, rough handling beyond specifications may result in damage to the unit.
- Federal Law (USA) restricts this device to sale by or on the order of a physician.



## DEFIBRILLATOR

<p><b>TYPE</b> Semi-Automatic external defibrillator</p> <p><b>MODEL</b> DDU-2300 series</p> <p><b>WAVEFORM</b> Biphasic Truncated Exponential (Impedance compensated)</p>	<p><b>ENERGY</b> Adult: 150 Joules Child/Infant: 50 Joules (Nominal into 50 Ohm load)</p> <p><b>CONTROLS</b> Lighted ON/OFF button Lighted Shock button</p> <p><b>CHARGE TIME*</b> Less than 4 seconds (shock decision to shock)</p>	<p><b>DISPLAY</b> High-resolution color LCD</p> <p><b>VIDEO PROMPTS</b> Full motion video On-screen text prompts</p> <p><b>CPR COACHING</b> Video and voice coaching On-demand video help</p>	<p><b>VOICE PROMPTS</b> Extensive voice prompts guide user through operation of the unit.</p> <p><b>RESCUE PROTOCOL</b> AHA/ERC 2010 Supports protocol updates by the user (password protected)</p>
--	--	---	---

\*Typical, with new battery at 25°C

## PATIENT ANALYSIS SYSTEM

<p><b>PATIENT ANALYSIS</b> Automatically evaluates patient impedance for proper pad contact. Monitors signal quality and analyzes patient ECG for shockable/non-shockable rhythms</p>	<p><b>SENSITIVITY/SPECIFICITY</b> Meets AAMI-DF-80 specifications and AHA recommendations.</p>
---	--

## BATTERY PACK

<p><b>MODEL</b> DBP-2003</p> <p><b>POWER</b> 12V, 2800 mAh</p> <p><b>TYPE</b> Lithium/Manganese Dioxide Disposable, recyclable, non-rechargeable</p>	<p><b>CAPACITY*</b> 125 shocks or 8 hours continuous operation</p> <p><b>STANDBY LIFE*</b> 4 years</p> <p><b>LOW BATTERY INDICATIONS</b> Visible Audible</p>
--	--

\*Typical, with new battery at 25°C

## SELF-TESTS

<p><b>AUTOMATIC</b> Automatic daily, weekly and monthly circuitry tests</p>	<p><b>BATTERY INSERTION</b> System integrity test on battery insertion</p> <p><b>PAD PRESENCE</b> Pads preconnected tested daily</p>	<p><b>USER-INITIATED</b> Unit and battery pack system test initiated by the user</p> <p><b>STATUS INDICATION</b> Visual and audible indication of unit status</p>	<p><b>STATUS SCREEN</b> Unit self-tests results. Pads and battery information (status and expiration)</p>
---	--	---	---

## DEFIBRILLATION / MONITORING PADS

<p><b>MODEL</b> Adult – DDP-2001 Child/Infant – DDP-2002</p>	<p><b>SURFACE AREA</b> 77cm<sup>2</sup> (nominal, each pad) 50cm<sup>2</sup> (nominal, each pad)</p>	<p><b>TYPE</b> Pre-connected, single-use, non-polarized, disposable, self-adhesive electrodes with cable and connector</p>
--	--	--

## EVENT DOCUMENTATION

<p><b>INTERNAL EVENT RECORD</b> Critical ECG segments and rescue event parameters are recorded (greater than 60 minutes) and can be downloaded to a removable data card.</p> <p><b>PC-BASED EVENT REVIEW</b> ECG with event tag display, and audio playback when available</p>	<p><b>REMOVABLE STORAGE</b> (optional) Up to 30 hours of ECG and event data storage (no audio option) or up to 3 hours of audio (audio option). ECG and event storage on a removable data card. Actual length of storage is dependent on card capacity.</p>	<p><b>USB PORT</b> Event download and maintenance operations</p>
--	---	--

## ENVIRONMENTAL

<p><b>TEMPERATURE</b> Operating: 0 to 50°C (32 to 122°F) Standby: 0 to 50°C (32 to 122°F)</p> <p><b>RELATIVE HUMIDITY</b> Operating/Standby: 5%-95% (non-condensing)</p> <p><b>ALTITUDE</b> -500 to 15,000ft (-150 to 4500m) per MIL-STD-810F 500.4 Procedure II</p> <p><b>VIBRATION</b> Ground (MIL-STD-810F 514.5 Category20)</p>	<p>Helicopter (RTCA/DO-160D, Section 8.8.2, Cat R, Zone 2, Curve G) Jet Aircraft (RTCA/DO-160D Section 8, Cat H, Zone 2, Curves B &amp; R)</p> <p><b>SHOCK/DROP ABUSE TOLERANCE</b> MIL-STD-810F 516.5 Procedure IV 48 inches (1.2 meters), any edge, corner, or surface, in standby mode</p> <p><b>CRUSH TEST</b> 1,000 pounds (450kg)</p>	<p><b>SEALING/WATER RESISTANCE</b> IEC60529 class IP55; Protected against dust and waterjets (battery pack installed)</p> <p><b>ESD</b> EN61000-4-2: (Open air up to 8kV or direct contact up to 6kV)</p> <p><b>EMC (Emission)</b> CISPR 11 Group 1 Level B and FCC Part 15</p> <p><b>EMC (Immunity)</b> IEC 61000-4-3 and IEC 61000-4-8</p>
---	---	--

## PHYSICAL

<p><b>SIZE</b> 7.3 x 9.5 x 2.3 Inches (18.5 x 24 x 5.8 cm)</p> <p><b>WEIGHT</b> Less than 3 lbs (1.4kg) (with battery)</p>
--



**ORIGINAL END USER'S LIMITED WARRANTY**

**COVERAGE**

Defibtech, LLC provides a limited warranty that the defibrillator and its associated accessories (e.g., batteries and pads), whether purchased concurrently with the defibrillator as part of a configuration or separately, shall be substantially free from defects in material and workmanship. Defibtech's limited warranty shall only extend to the original end user, where the original end user purchased the items from an authorized Defibtech, LLC retailer. This limited warranty may not be assigned or transferred. The terms of the Limited Warranty in effect as of the date of original purchase shall apply to any warranty claims.

**LENGTH OF WARRANTY**

The defibrillator's limited warranty is for a period of five (5) years from the date of purchase. The battery's limited warranty is for a period of four (4) years from the date of purchase, but in no event shall the limited warranty period extend past the date printed on the battery. Single use accessories (e.g., the pads) shall have a limited warranty up to use or for a period up to the expiration date, whichever is earlier. The limited warranty for all other accessories is for a period of one (1) year from the date of purchase, or to the expiration date, whichever is earlier.

**LIMITED WARRANTY LIMITATIONS**

This limited warranty does not cover damage of any sort resulting from, but not limited to, accidents, improper storage, improper operation, alterations, unauthorized service, tampering, abuse, neglect, fire, flood, war, or acts of God. Additionally, this limited warranty does not cover damage of any sort to the defibrillator or its associated accessories resulting from the use of the defibrillator with unapproved accessories or use of the accessories with unapproved medical devices. The defibrillator and its associated accessories are not warranted to be compatible with any other medical device.

**LIMITED WARRANTY VOIDED**

The limited warranty is immediately voided if: the defibrillator or its associated accessories are serviced or repaired by any entity, including persons, not authorized by Defibtech, LLC; specified maintenance is not performed; the defibrillator is used with one, or more, unauthorized accessories; the associated accessories are used with an unauthorized defibrillator; or the defibrillator or associated accessories are not used in accordance with Defibtech, LLC approved instructions.

**EXCLUSIVE REMEDY**

At Defibtech, LLC's sole discretion, Defibtech shall have the option to repair, replace, or provide a credit. In the event of replacement, Defibtech shall have the right at its sole discretion to replace the item with a new, or refurbished, same or similar item. Determination of a similar item shall be at the sole discretion of Defibtech. In the case of replacement, the replacement at a minimum shall reflect the prorated time remaining for the item based on the remaining limited warranty period. In the case of a credit, the credit shall be the prorated value of the item based on the lower of the original item cost of the same or similar item and the remaining limited warranty period. In no event, shall the limited warranty period of a replacement item extend past the limited warranty period of the item it is replacing.

**WARRANTY SERVICE**

In order to obtain warranty service, contact the retailer from whom the item was purchased, or Defibtech, LLC customer service. In the event an item must be returned, a Return Material Authorization (RMA) number is required. Items returned without an RMA number will not be accepted. The item shall be shipped at the original end user's expense to a destination specified by the retailer or Defibtech, LLC.

**OBLIGATIONS AND WARRANTY LIMITS**

THE FOREGOING LIMITED WARRANTY IS IN LIEU OF AND SPECIFICALLY EXCLUDES AND REPLACES, TO THE DEGREE PERMITTED BY APPLICABLE STATE LAW, ALL OTHER EXPRESS OR IMPLIED WARRANTIES, INCLUDING, BUT NOT LIMITED TO, THE IMPLIED WARRANTIES OF MERCHANTABILITY AND FITNESS FOR A PARTICULAR PURPOSE.

NO PERSON (INCLUDING ANY AGENT, DEALER, OR REPRESENTATIVE OF DEFIBTECH, LLC) IS AUTHORIZED TO MAKE ANY REPRESENTATION OR WARRANTY CONCERNING THE DEFIBRILLATOR OR ITS ASSOCIATED ACCESSORIES, EXCEPT TO REFER TO THIS LIMITED WARRANTY.

THE EXCLUSIVE REMEDY WITH RESPECT TO ANY AND ALL LOSSES OR DAMAGES RESULTING FROM ANY CAUSE WHATSOEVER SHALL BE AS SPECIFIED ABOVE. DEFIBTECH, LLC SHALL IN NO EVENT BE LIABLE FOR ANY CONSEQUENTIAL OR INCIDENTAL DAMAGES OF ANY KIND, INCLUDING, BUT NOT LIMITED TO, EXEMPLARY DAMAGES, SPECIAL, PUNITIVE, COMMERCIAL LOSS FROM ANY CAUSE, BUSINESS INTERRUPTION OF ANY NATURE, LOSS OF PROFITS OR PERSONAL INJURY, EVEN IF DEFIBTECH, LLC HAS BEEN ADVISED OF THE POSSIBILITIES OF SUCH DAMAGES, HOWEVER OCCASIONED, WHETHER BY NEGLIGENCE OR OTHERWISE, UNLESS APPLICABLE STATE LAW DOES NOT ALLOW SUCH EXCLUSION OR LIMITATION.

**Manufacturer**

Defibtech, LLC  
741 Boston Post Road  
Guilford, CT 06437

Tel.: (866) 333-4241 (Toll-free within North America)  
(203) 453-4507  
Fax: (203) 453-6657

Emails:  
sales@defibtech.com (Sales)  
reporting@defibtech.com (Medical Device Reporting)  
service@defibtech.com (Service and Repair)

**European Authorized Representative**

**EC REP**

Emergo Europe  
Molenstraat 15  
2513 BH The Hague  
The Netherlands  
Tel.: +31 70 345 8570  
Fax: +31 70 346 7299

Patents pending.

This product and its accessories are manufactured and sold under one or more of the following United States patents: D523,393, D548,346, D551,628.

This product and its accessories are manufactured and sold under license to at least one or more of the following United States patents: 5,591,213; 5,593,427; 5,601,612; 5,607,454; 5,611,815; 5,617,853; 5,620,470; 5,662,690; 5,735,879; 5,749,904; 5,749,905; 5,776,166; 5,800,460; 5,803,927; 5,836,978; 5,836,993; 5,879,374; 6,016,059; 6,047,212; 6,075,369; 6,438,415; 6,441,582.